

# LEE Classic Turret Press

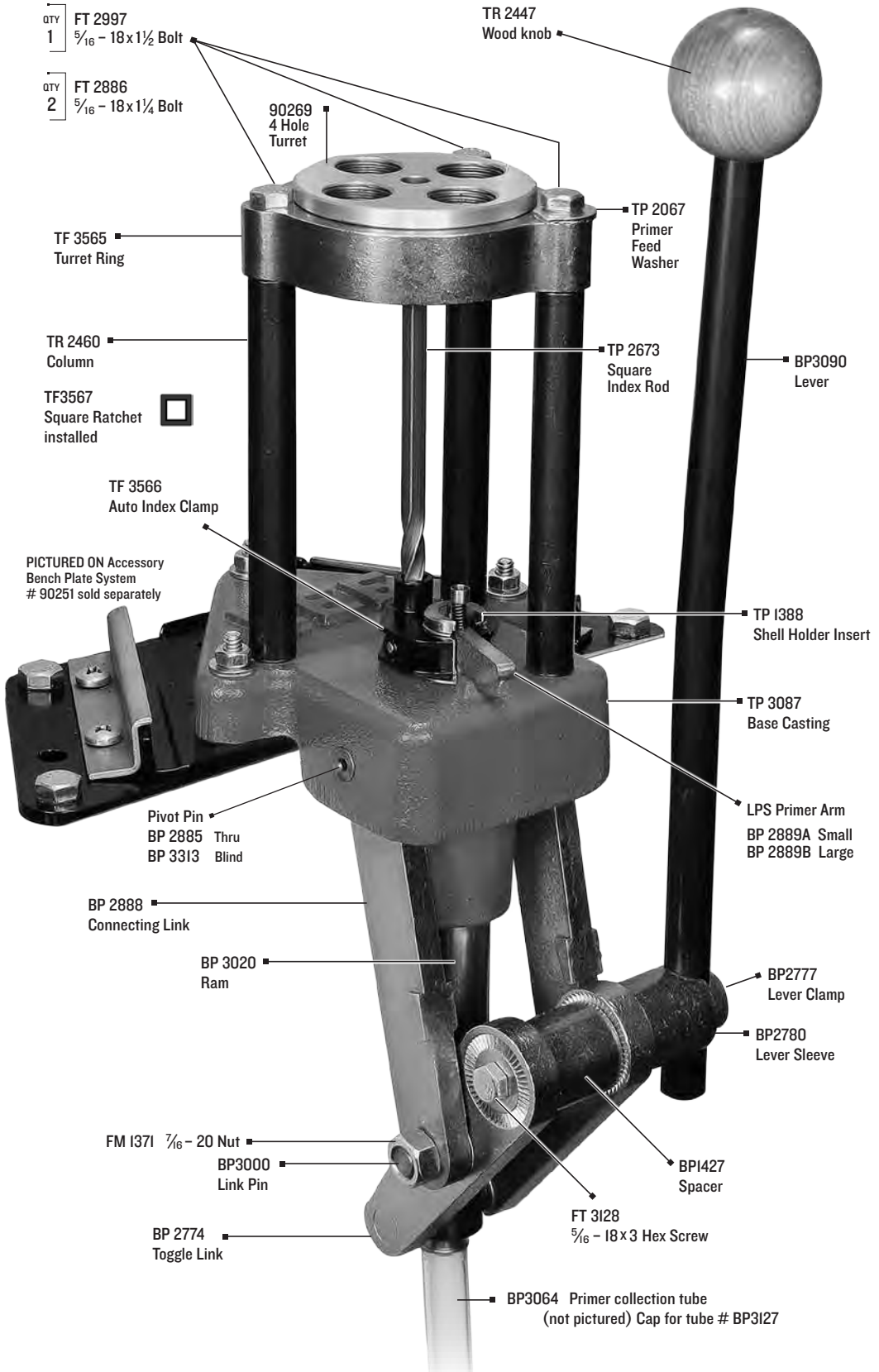

QTY 1 FT 2997  
1/16 - 18 x 1 1/2 Bolt

QTY 2 FT 2886  
5/16 - 18 x 1 1/4 Bolt

TR 2447  
Wood knob

90269  
4 Hole  
Turret

TF 3565  
Turret Ring

TP 2067  
Primer  
Feed  
Washer

TR 2460  
Column

TP 2673  
Square  
Index Rod

BP3090  
Lever

TF3567  
Square Ratchet  
installed

TF 3566  
Auto Index Clamp

PICTURED ON Accessory  
Bench Plate System  
# 90251 sold separately

TP I388  
Shell Holder Insert

TP 3087  
Base Casting

Pivot Pin  
BP 2885 Thru  
BP 3313 Blind

LPS Primer Arm  
BP 2889A Small  
BP 2889B Large

BP 2888  
Connecting Link

BP 3020  
Ram

BP2777  
Lever Clamp

BP2780  
Lever Sleeve

FM I371 7/16 - 20 Nut

BP3000  
Link Pin

BPI427  
Spacer

BP 2774  
Toggle Link

FT 3128  
5/16 - 18 x 3 Hex Screw

BP3064 Primer collection tube  
(not pictured) Cap for tube # BP3127

# LEE

**LEE PRECISION, INC.**  
4275 Hwy U · Hartford WI 53027  
www.leeprecision.com

# CAUTION

Ammunition reloading can be dangerous if done improperly and should not be attempted by persons not willing and able to read and follow instructions exactly. Children should not be permitted to reload ammunition without strict parental supervision. Always wear safety glasses when reloading and shooting. Ammunition loaded with these tools and data should only be used in modern guns in good condition. We do not accept responsibility for ammunition loaded with these tools or data as we have no control over the manufacture and storage of components or the loading procedure and techniques. Primers and gun powders, like gasoline and matches, can be dangerous if improperly handled or misused.

## RELOADING SAFETY

Keep powder away from heat and open flames — Don't smoke

Store powder and primers in their original containers in a cool, dry place

Read and follow instructions exactly

Be sure you have the correct powder, measure and bullet of the correct weight  
Any mixup can be dangerous

Exercise care and common sense at all times

**WEAR SAFETY GLASSES WHEN RELOADING OR SHOOTING**

**LEAD WARNING** Primers contain lead: a substance known to cause birth defects, reproductive harm, and other serious physical injury. Wash hands after exposure.

### CROSS SECTION OF A TYPICAL CARTRIDGE

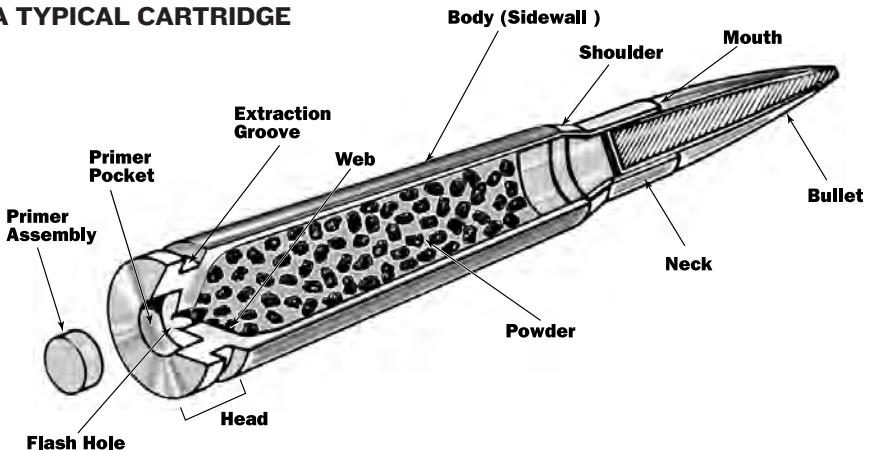

### RELOADING IS QUITE A SIMPLE PROCESS

- 1 Case is sized to original dimensions and the spent primer is removed
- 2 Install a new primer
- 3 Add a charge of powder
- 4 Seat a new bullet and crimp if desired

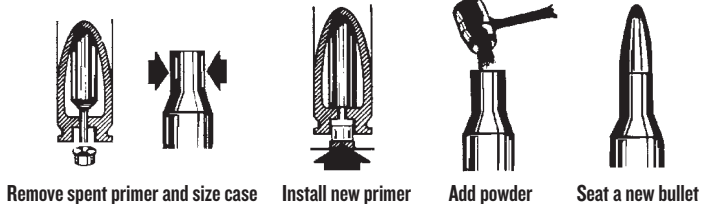

### IT IS YOUR RESPONSIBILITY TO ENSURE THE SAFETY OF YOUR LOADS

The following are factors that will increase pressures. Some will be dangerous.

- DO NOT USE more powder than recommended
- DO NOT USE a heavier bullet than recommended
- DO NOT SEAT the bullet deeper than normal
- DO NOT USE magnum primers unless using a slow burning ball powder
- Greatly oversize bullets, excessively hard bullets or cases that are too long will cause higher pressures.
- High temperatures, or cartridges that were stored in a hot car or car trunk will produce higher pressures

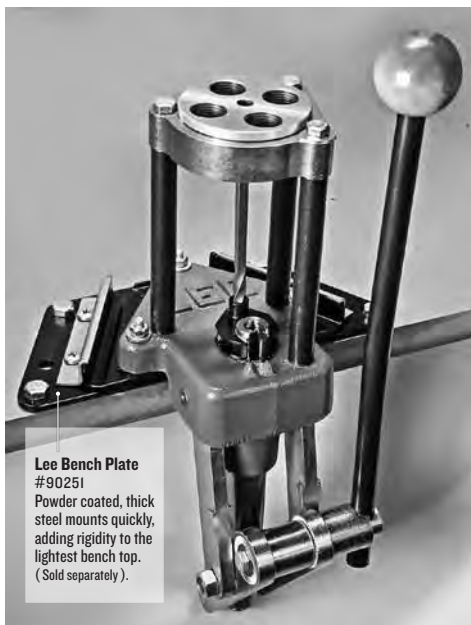

**Lee Bench Plate #90251**  
Powder coated, thick steel mounts quickly, adding rigidity to the lightest bench top. (Sold separately).

**FIGURE 1**  
Attach the Classic Turret Press to the front edge of a sturdy bench using three  $\frac{1}{4}$  or  $\frac{5}{16}$  inch bolts, or mount to Lee Bench Plate System, #90251. (Sold separately).

Slide the clear plastic PVC tube onto the end of the ram. Spent primers pass through the drilled ram and are collected in the clear tube. This feature collects every primer and keeps the ram-bearing surface free of dirt and grit. A cap is provided for convenient disposal or the tube can be routed directly to a trashcan.

Lubricate the ram and all pivot points with a light-weight oil—gun, sewing machine or any weight motor oil will work. Avoid water-displacing oils such as WD-40. Coat bare metal parts with oil for storage like you would any fine firearm.

## BEFORE YOU START RELOADING SETTING UP YOUR LEE CLASSIC TURRET PRESS

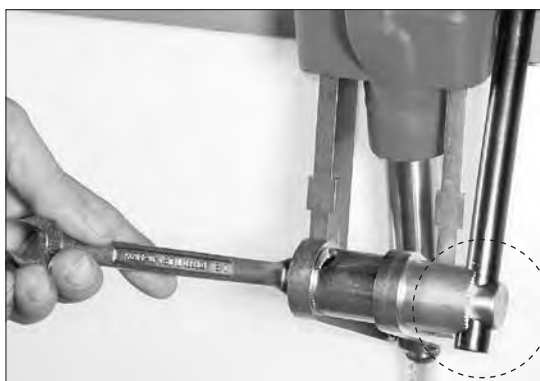

**FIGURE 2**  
Slide the press frame back onto the bench to where it stops against the vertical surfaces adjacent to the ram. Slide the lever through the lever clamp. • **Be sure the lever passes completely through the lever sleeve.** The lever has a curve in the length to allow clearance for the primer feed. Adjust the curve to the most comfortable position and secure clamp bolt.



**FIGURE 3**

## DIE INSTALLATION



**A** Snap the shell holder into the shell holder insert. Be sure the primer arm falls between the bumps on the base. The end of the ram can be rotated to properly align the arm to the base. This alignment is critical to proper priming and turret indexing. Install and adjust dies following the manufacturers' instructions.

**B** Cycle the press up and down. If the turret does not stop in the correct position—follow these instructions. With the ram in the down position, place a  $\frac{1}{4}$ " wrench on the index rod and hold in position; now rotate the turret to the correct position.



**NOTE** To remove the turret, lift while rotating

The Auto Index is usable on cases with overall length of  $3\frac{1}{16}$ " or less. To deactivate auto index, simply remove index rod.

# YOU CAN NOW BEGIN RELOADING

For a lifetime of service, oil the turret, ram and all pivot pins before each use



Carbide dies need no lubrication

The following sequence demonstrates steps necessary to load a single round. While it may look complicated, it is really only two or three strokes of the lever.

**1 PREPARE YOUR CASES** Inspect your cases while lubricating them. Discard all cases with split necks, indications of head separation or other defects. Wipe on a thin film of Lee Case Lubricant with your fingers. Fingers are the best way of lubing a case as any grit that could damage the die is wiped away. The case may be immediately sized or you can let the lube dry.



**RIFLE DIES ONLY** Be sure to lube the inside of the case neck with a cotton swab.

## CAUTION

If for any reason you do not use Lee Resizing Lubricant, be very careful not to contaminate the powder or primers. All other brands are oil based and they have serious, detrimental effects on powder and primers. Because of the stickiness, they also attract grit that can damage the die. Lee Resizing Lubricant costs less and is so superior that it is worth the effort to insist upon it or order direct from the factory.



**2 SIZE THE CASE** Place a shell in the shell holder. Rotate the turret to position the full length sizer over the case. Firmly raise the ram to the top and stop.



**3 SELECT CORRECT LEVER PRIME ASSEMBLY** (large or small). With clean fingers, place the correct size and type of primer in the primer guide. (This operation is greatly speeded by using the Lee Safety Prime primer feeder. Never touch the primer from box to shell.) Seat the primer by lowering the ram—lifting up on the press lever. Lift firmly enough to seat the primer flush to slightly below flush of the case head.



To determine small vs. large lever assembly, note difference, **SMALL** (left) **LARGE** (RIGHT)

**AUTO-DRUM POWDER MEASURE** pictured with riser installed. Case actuates the measure to automatically drop exact charge while expanding the case mouth. If you plan on utilizing the Safety Prime on your press, install Auto Disk Rister #90041 (sold separately).

**CHARGING THE CASE** Regardless of how you charge the case, be absolutely certain you have the correct amount and type of powder for the bullet you have selected. **NEVER try to seat the primer deeper after the powder has been added.**

THIS STEP IS OMITTED WITH MOST RIFLE DIES

**4 FLARE CASE MOUTH** for ease of bullet installation. Raise the ram to expand the case neck. To increase the flare, screw the die in deeper. Always adjust to provide the minimum flare needed to start the bullet. After proper adjustment, tighten the lock ring.

**5 SEAT BULLET** on the case mouth and guide it into the die. If you are using a three die set, you must carefully adjust the bullet seating die body so that a crimp is applied as the bullet is seated. Follow the instructions included with your die set. With a four hole turret press, most users find it easier to seat and crimp in separate operations. The Lee Factory Crimp die is best, as it gives factory-like feed and dependability to your reloads.



**6 IF LOADING** maximum loads, it's good practice to remove all traces of case lubricant with detergent and water. This reduces pressure against the bolt.

# TURRET PRESS PRIMER FEED INSTRUCTIONS

PRIMER FEED WASHER SHIPS WITH YOUR TURRET PRESS. PRIMER FEED BRACKET SHIPS WITH SAFETY PRIME

**1** INSTALL primer feed bracket using supplied washer and bolt as pictured. Orient bracket with feeder installed to lever prime. Lightly tighten bolt with 1/2" wrench.



**2** INSTALL appropriate primer arm. Cycle up and down to insure proper orientation.



**3** Slide the flow control OPEN



**4** Unfold tray and place on top of box of 100 primers.

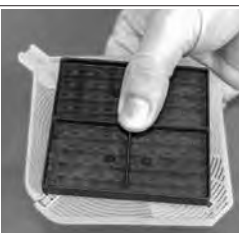

**5** Flip tray over to deposit the primers.

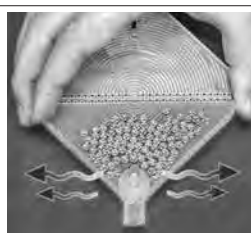

**6** Shake tray side to side to upright all the primers. Close cover.

**7** SLIDE the flow control to lock, and slide trough and tray together, making sure that the trough is completely seated.



**8** SELECT correct primer feed assembly

SMALL black trigger assembly  
LARGE white trigger assembly  
SLIDE primer feed into case feed bracket.  
Snug bolt with 1/2" wrench.  
SLIDE the tray flow control valve to ON



**9** DE-PRIME and size case as normal. With ram at the top of the stroke (handle down), push trigger on the primer feed to dispense a primer.  
**NOTE** Trigger has to be fully forward, then down to dispense primer.



**10** LOWER ram (raise handle) to seat primers. The primers should be flush to slightly below flush when properly seated.



## ★ SMOOTH OPERATION TIP ★

Spent primers are extremely dirty, and after extended use it may be necessary to clean ram where primer lever is inserted. Clean the ram using gun scrubber, electrical contact cleaner or disc brake cleaner. Be sure to lubricate outside of ram with #30 weight motor oil or equivalent.

## CHANGING primer sizes can be done in seconds!

- Replace L-shaped primer arm with appropriate size
- Substitute appropriate feed assembly



## TURRET PRESS USERS

If using the Case Activated Powder Measure, the riser should be installed to give sufficient clearance between the primer tray and powder measure body.

RISER  
catalog #90041

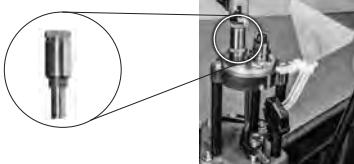

## ADJUSTING THE INDEX

Cycle the press up and down. If the turret does not stop in the correct position—follow these instructions.

With the ram in the down position, place a  $\frac{1}{4}$ -inch wrench on the index rod and hold in position. Now rotate the turret into the correct position. Never use a pliers as index rod damage will occur.

### PARTS LIST FOR THE FOUR HOLE AUTO INDEX

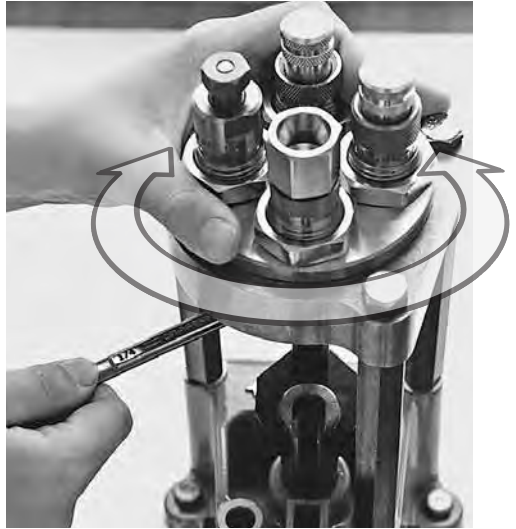
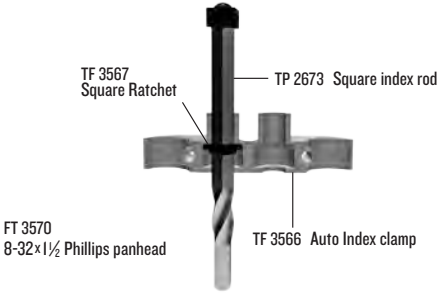

### CASES

The easiest and best way of getting cases is to simply save those from your factory loaded rounds. New and used cases can also be purchased. Cases must be clean and safe. Do not use cases that have cracks or splits. If they have been used more than twice, they should be checked to see that none of them have become too long for safe use. The easiest way is to trim them is with a Lee Case Trimmer. This automatically cuts them to the correct length and no gauging or measuring is needed. After trimming, be sure to chamfer both the inside and outside of the case. A Lee Chamfer Tool works best, but it can be done with a pocket knife.

Straight sided cases, such as those used by most handguns, are loaded with a 3–die set.

### MILITARY CASES

Used military cases are readily available at low cost. Usually, these have primers that are crimped in place. This is to prevent the primer from coming loose in automatic weapons and jamming the action at an inopportune time. The crimp must be removed before repriming. This can be done with a primer pocket reamer or swaging tool. Even a Lee Chamfer Tool can be used to ream the crimp.

### POWDER

Powder is usually classified as smokeless and black powder. There is also Pyrodex, which is a substitute for black powder. We will be using only smokeless powder for reloading.

Each set of Lee Dies is supplied with powder measure and charge table with a generous selection of loads. Additional load data is available from all the powder manufacturers and bullet makers. This is excellent information and should be followed exactly.

Different powders are available to do different jobs. Bullets having a high sectional density (long length in relation to their diameter) require a slow burning powder. This permits sustained peak pressure to gain maximum acceleration within working pressure limits.

Short, light bullets use quicker burning powder for complete combustion within the barrel. A wide selection of powder is readily available. Powders should always be stored in their original containers. While smokeless powder is not an explosive and not as dangerous to handle as gasoline, it would be foolish to handle it carelessly and store excessive

amounts. Follow the powder manufacturers' recommendations for storage and use.

### PRIMERS

Rifle and pistol cartridges require different primers. Rifle primers have a thick and stronger cup to withstand the higher pressure. Pistol primers have a thinner cup for easy detonation with a lighter hammer blow. Both rifle and pistol primers are available in regular and magnum. Use regular for all loads except if the load data specifies magnum primers.

Primers must always be stored in their original containers. It is always a wise idea to wear safety or shooting glasses when shooting or reloading.

### BULLETS

Commercial rifle bullets usually have a soft lead core with a copper jacket. Point shapes come in a variety of styles, but usually have some soft lead exposed to properly mushroom on impact.

The jackets serve a dual purpose: to control the bullet expansion and act as a bearing surface for its high speed travel down the bore. Some bullets have a crimping groove called a cannelure. This groove must be seated almost entirely in the case when crimping the case. The very end of the case mouth is turned into this groove by the bullet seating die used in a tubular magazine gun and most revolver ammunition.

Cast bullets are very popular with the handloader. These are very economical to use and for all guns where the velocity is less than 2,000 feet per second and can be as accurate as jacketed bullets. They do not normally expand as well as soft lead jacketed bullets on game. Therefore, it is poor economy to use them for hunting.

### CRIMPING

Ammunition loaded for hunting should always have the bullets crimped in place, as should ammunition used in tubular magazine and auto-loading rifles. It could ruin your hunt if a bullet wedged in the chamber or pushed back into the case. Best accuracy is usually obtained with crimped ammo as the crimp has an effect on ignition, velocity, pressure and ballistic consistency. No die does a better job crimping than the Lee Factory Crimp Die.

## THE LEE GUARANTEE

Lee Reloading products are guaranteed not to wear out or break from normal use for two full years, or they will be repaired or replaced at no charge if returned to the factory. Any Lee product of current manufacture, regardless of age or condition, will be reconditioned to new, including a new guarantee, if returned to the factory with payment equal to half the current retail price.